



UMR-HPC SERIES

125 to 30,000V, 60 to 250W
Standard DC/DC Modules



Features

- Capacitor Charging High Voltage Power Supplies
- Regulated Output Voltage from V_{OUT} Max to True Zero
- Wide Input Voltage Range
- Indefinite Output Short Circuit Protection
- Output Voltage and Current Monitors
- Fixed-Frequency, Low-Stored-Energy Design
- Designed for Continuous Output Power
- UL/cUL Recognized Component; CE Mark (LVD and RoHS)

Specifications

Conditions		Value			Units
Input		60W	125W	250W	
Voltage	Nominal	+24	+24	+24	VDC
Voltage Range	Full Power	+23 to 30	+23 to 30	+23 to 30	VDC
Voltage Range	Derated Power Range	+10 to 32	+10 to 32	+15 to 30	VDC
Current	Standby/Disable	<90	<90	<90	mA
Current	No Load, Max V_{OUT}	<500	<500	<600	mA
Current	Full Load, Max V_{OUT}	<3.25	<6.30	<13.50	A
AC Ripple Current	Nominal Input, Full Load	<150	<200	<200	mAp-p
Output					
Static Load Regulation	No Load to Full Load, Max V_{OUT}	<0.01			%VDC
Line Regulation	Nominal Input, Max V_{OUT} , Full Power	<0.08			%VDC
Stability	30-minute warmup, per 8h/per day	<0.01 / <0.02			%VDC
High Frequency Ripple	Full Load, 1Hz to 1MHz, Max E_{OUT}	<1.00			%Vp-p
Programming & Controls					
Input Impedance	Nominal Input, Positive Models	1.0 to Signal Ground			MΩ
	Nominal Input, Negative Models	1.1 to V_{REF}			
Adjust Resistance	Typical Potentiometer Values	10K to 100K (Pot Across V_{REF} and Signal Ground, Wiper to Adjust)			Ω
Adjust Logic (V_{ADJ})¹	Positive Models	0 to +4.64 = 0 to 100% Rated Output			VDC
	Negative Models	+5 to +0.36 = 0 to 100% Rated Output			
Reference Voltage (V_{REF})	Temperature +25°C	+5 ± 0.5%			VDC
Enable/Disable HV_{OUT}	-	Unconnected = Enabled; Ground to +0.5 = Disabled; +2.4 to 32 = Enabled			VDC
Environmental					
Operating Temperature²	Case Temperature, Full Load, Max V_{OUT}	-40 to +65			°C
Temperature Coefficient	Over the Specified Temperature	±50			PPM/°C
Thermal Shock	Mil-Std-810, Method 503-4, Proc. II	-40 to +65			°C
Storage Temperature	Non-Operating, Case Temperature	-55 to +105			°C
Humidity	All Conditions, Standard Package	0 to 95% Non-Condensing			-
Altitude	All Conditions, Standard Package	Sea Level through Vacuum			-
Shock	Mil-Std-810, Method 516.5, Proc IV	20			G
Vibration	Mil-Std-810, Method 514.5, Fig 514.5C-3	10			G

¹V05 or V10 Options (additional details on pg.7)

²Typically, convection cooled. Units operating at full power might require additional cooling to maintain case temperature below 65°C. Damage to the power supply may occur if not appropriately cooled during use.



UMR-HPC SERIES

Part Number ³	Output Voltage VDC	Output Current mA	Output Capacitance μ F	I _{MON} Scaling ⁴ mA/V	V _{MON} Scaling ⁵
60W Models					
UMR-HPC-125*-60	0 to 125	480.00	2.20000	400.00	100:1 \pm 1%
UMR-HPC-250*-60	0 to 250	240.00	1.00000	200.00	100:1 \pm 1%
UMR-HPC-500*-60	0 to 500	120.00	0.33000	109.00	100:1 \pm 1%
UMR-HPC-1000*-60	0 to 1000	60.00	0.15000	50.00	100:1 \pm 1%
UMR-HPC-2000*-60	0 to 2000	30.00	0.15000	26.00	100:1 \pm 1%
UMR-HPC-4000*-60	0 to 4000	15.00	0.10000	11.50	100:1 \pm 1%
UMR-HPC-6000*-60	0 to 6000	10.00	0.00660	6.20	100:1 \pm 1%
UMR-HPC-8000*-60	0 to 8000	7.50	0.00250	4.70	1000:1 \pm 1%
UMR-HPC-10000*-60	0 to 10000	6.00	0.00200	4.10	1000:1 \pm 1%
UMR-HPC-12000*-60	0 to 12000	5.00	0.00150	4.00	1000:1 \pm 1%
UMR-HPC-15000*-60	0 to 15000	4.00	0.00110	4.00	1000:1 \pm 1%
UMR-HPC-20000*-60	0 to 20000	3.00	0.00088	0.65	1000:1 \pm 1%
UMR-HPC-25000*-60	0 to 25000	2.40	0.00073	0.65	1000:1 \pm 1%
UMR-HPC-30000*-60	0 to 30000	2.00	0.00050	0.65	1000:1 \pm 1%
125W Models					
UMR-HPC-125*-125	0 to 125	1000.00	2.20000	833.00	100:1 \pm 1%
UMR-HPC-250*-125	0 to 250	500.00	1.00000	417.00	100:1 \pm 1%
UMR-HPC-500*-125	0 to 500	250.00	0.33000	208.00	100:1 \pm 1%
UMR-HPC-1000*-125	0 to 1000	125.00	0.15000	114.00	100:1 \pm 1%
UMR-HPC-2000*-125	0 to 2000	62.00	0.15000	52.00	100:1 \pm 1%
UMR-HPC-4000*-125	0 to 4000	31.00	0.10000	26.00	100:1 \pm 1%
UMR-HPC-6000*-125	0 to 6000	21.00	0.00660	17.70	100:1 \pm 1%
UMR-HPC-8000*-125	0 to 8000	15.50	0.00250	14.20	1000:1 \pm 1%
UMR-HPC-10000*-125	0 to 10000	12.50	0.00200	10.90	1000:1 \pm 1%
UMR-HPC-12000*-125	0 to 12000	10.50	0.00150	7.40	1000:1 \pm 1%
UMR-HPC-15000*-125	0 to 15000	8.30	0.00110	7.50	1000:1 \pm 1%
UMR-HPC-20000*-125	0 to 20000	6.25	0.00088	0.65	1000:1 \pm 1%
UMR-HPC-25000*-125	0 to 25000	5.00	0.00073	0.65	1000:1 \pm 1%
UMR-HPC-30000*-125	0 to 30000	4.17	0.00050	0.65	1000:1 \pm 1%
250W Models					
UMR-HPC-125*-250	0 to 125	2000.00	2.20000	1667.00	100:1 \pm 1%
UMR-HPC-250*-250	0 to 250	1000.00	1.00000	833.00	100:1 \pm 1%
UMR-HPC-500*-250	0 to 500	500.00	0.33000	417.00	100:1 \pm 1%
UMR-HPC-1000*-250	0 to 1000	250.00	0.15000	227.00	100:1 \pm 1%
UMR-HPC-2000*-250	0 to 2000	125.00	0.15000	104.00	100:1 \pm 1%
UMR-HPC-4000*-250	0 to 4000	62.00	0.10000	52.00	100:1 \pm 1%
UMR-HPC-6000*-250	0 to 6000	42.00	0.00660	35.00	100:1 \pm 1%
UMR-HPC-8000*-250	0 to 8000	31.20	0.00250	6.25	1000:1 \pm 1%
UMR-HPC-10000*-250	0 to 10000	25.00	0.00200	5.00	1000:1 \pm 1%
UMR-HPC-12000*-250	0 to 12000	20.80	0.00150	4.17	1000:1 \pm 1%
UMR-HPC-15000*-250	0 to 15000	16.70	0.00110	3.33	1000:1 \pm 1%
UMR-HPC-20000*-250	0 to 20000	12.50	0.00088	2.50	1000:1 \pm 1%
UMR-HPC-25000*-250	0 to 25000	10.00	0.00073	2.00	1000:1 \pm 1%
UMR-HPC-30000*-250	0 to 30000	8.33	0.00050	1.67	1000:1 \pm 1%

³For “.”, substitute “P” for positive output or “N” for negative output

⁴Full Scale Signal

⁵Into 10M Ω

Rise Time/Capacitor Charging

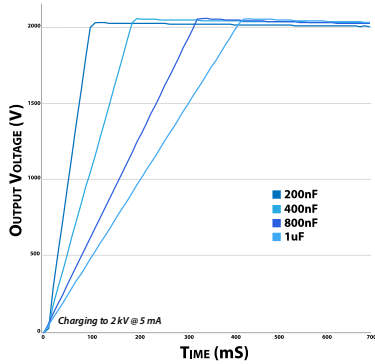

Typical Rise Time:

$$t_R = \frac{C + C_{ext}}{I_o} V_o$$

Minimum Rise Time is 10nS

Abbreviations:

- C Output Capacitance of Power Supply
- C_{ext} Capacitance of External Capacitor
- V_o Power Supply Output Voltage
- F Power Supply Discharge Frequency
- I_o Nominal Output Current
- t_r Rise Time

Mechanical Drawings and Pin Assignments

125V to 6kV, 60 to 125W

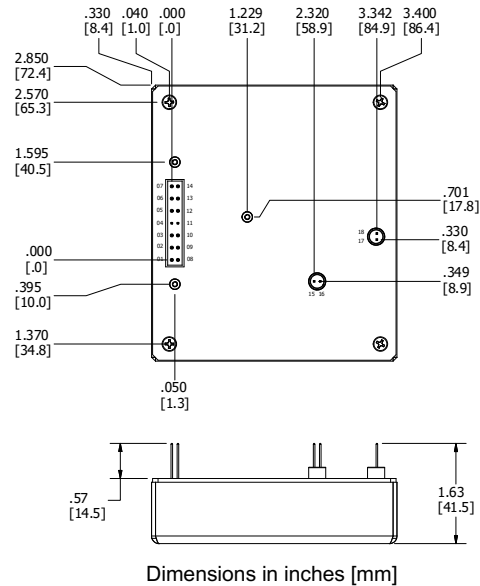
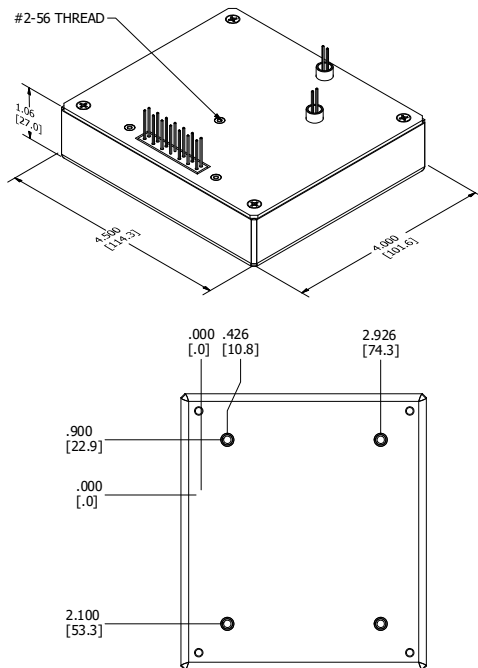



UMR-HPC SERIES

8 to 15kV, 60 to 125W

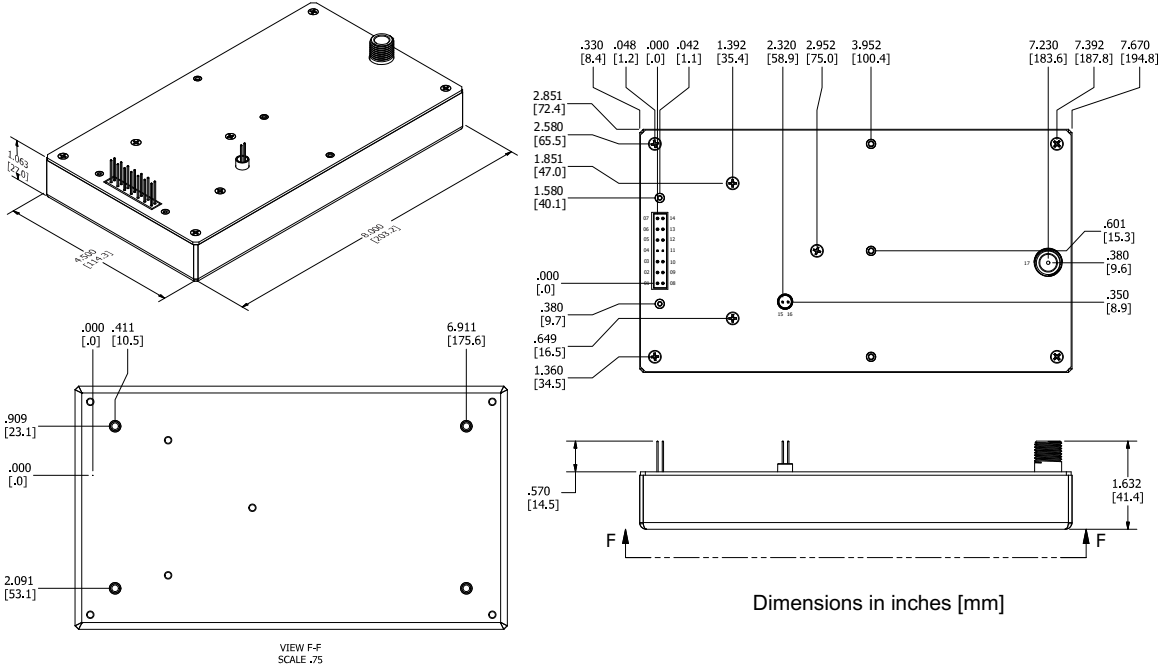

20 to 30kV, 60 to 125W

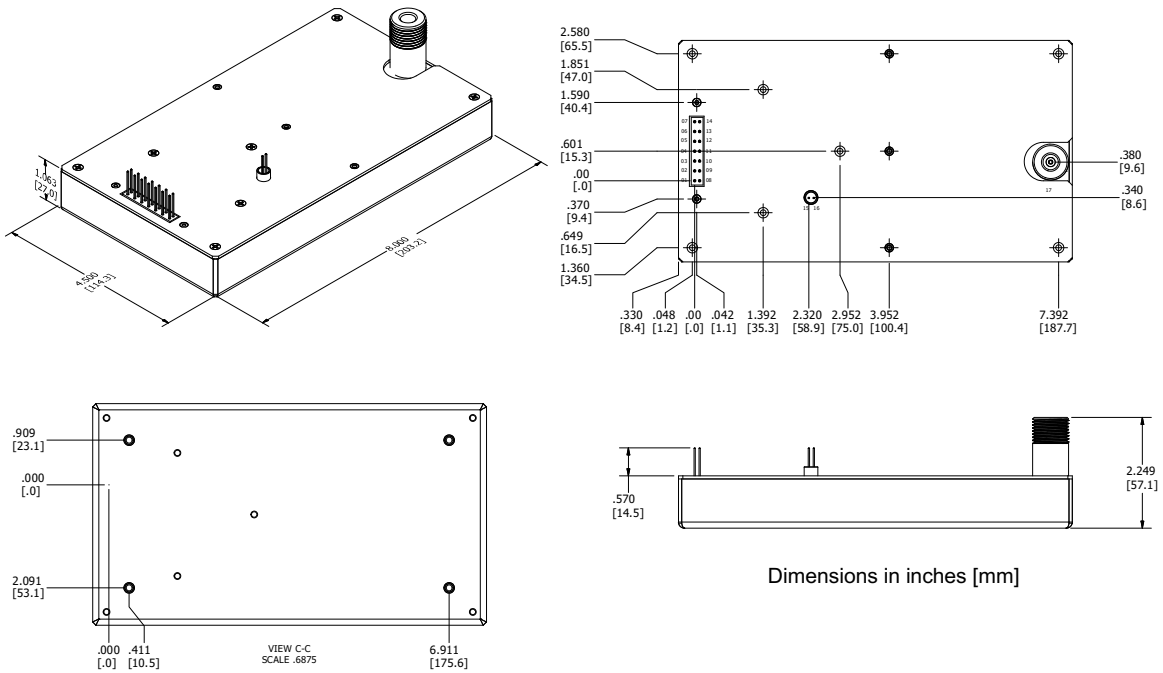



UMR-HPC SERIES

125V to 6kV, 250W

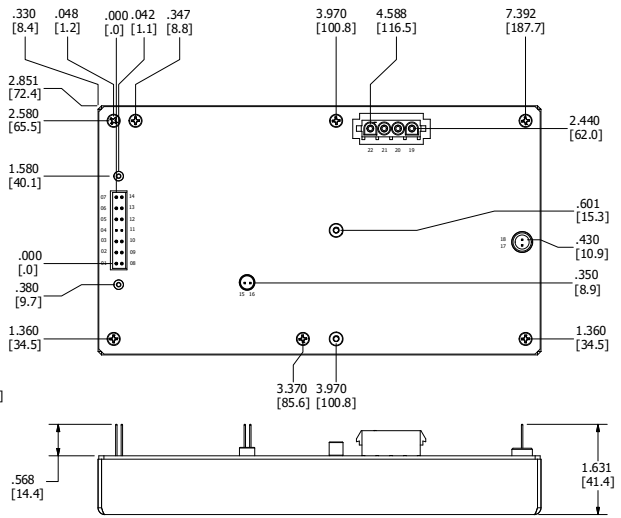
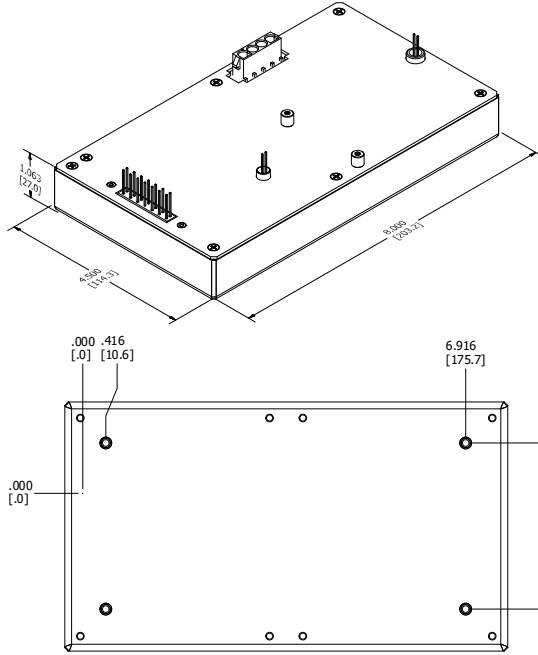

Dimensions in inches [mm]

8kV to 30kV, 250W

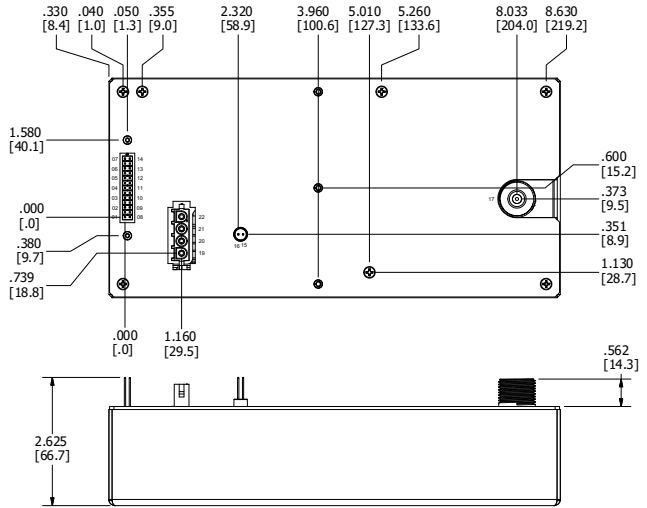
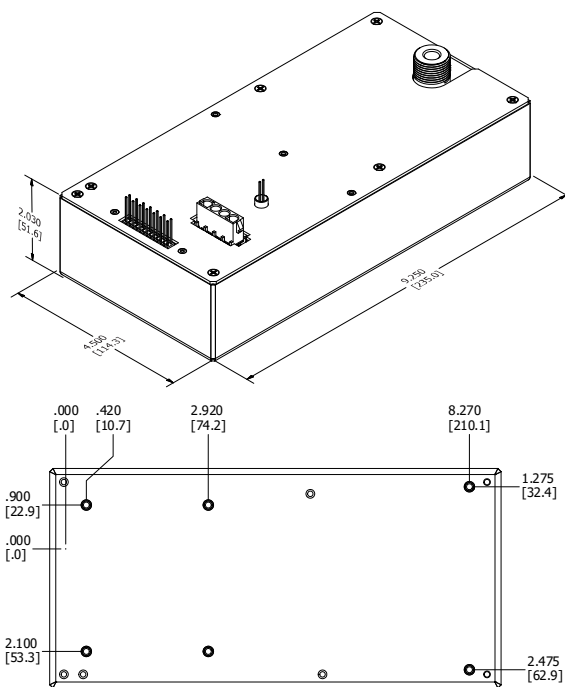

Dimensions in inches [mm]



UMR-HPC SERIES

Mechanical Specifications			
Volume	125V to 6kV	60 to 125W 250W	19.2in ³ [314cm ³] 38.7in ³ [634cm ³]
	8 to 30kV	60 to 125W 250W	38.3in ³ [628cm ³] 84.5in ³ [1385cm ³]
Weight	125V to 6kV	60 to 125W 250W	22oz [605g] 42oz [1200g]
	8 to 30kV	60 to 125W 250W	41oz [1164g] 88oz [2505g]
Case	Aluminum Anodized		
Pins	Size	0.025" [0.635mm] square	
	Spacing	Pins 1-7, 8-14	0.200in
		Pins 15-16, 17-18	0.100in

Tolerances	
Overall	0.050in [±1.27mm]
Pin to Pin	0.015in [±0.38mm]
Mounting	0.025in [±0.64mm]

60W & 125W Models

Pin Assignments & Connections		
Pin 1, 8	PWRGND	Input Power Ground Return
Pin 2, 9	+VIN	Positive Power Input
Pin 3	IMON	Output Current Monitor
Pin 4	ENABLE	Enable/Disable
Pin 5	SIGGND	Signal Ground Return
Pin 6	VADJ	Voltage Adjust
Pin 7	VREF	Voltage Reference
Pin 10	N/C	N/C
Pin 11	N/C	N/C
Pin 12	N/C	N/C
Pin 13	N/C	N/C
Pin 14	VMON	Output Voltage Monitor
Pin 15, 16	HVRTN	High Voltage Ground Return
Pin 17, 18	HVOUT	High Voltage Output

250W Models

Pin Assignments & Connections		
Pin 1, 8	N/C	N/C
Pin 2, 9	N/C	N/C
Pin 3	IMON	Output Current Monitor
Pin 4	ENABLE	Enable/Disable
Pin 5	SIGGND	Signal Ground Return
Pin 6	VADJ	Voltage Adjust
Pin 7	VREF	Voltage Reference
Pin 10	N/C	N/C
Pin 11	N/C	N/C
Pin 12	N/C	N/C
Pin 13	N/C	N/C
Pin 14	N/C	N/C
Pin 15, 16	HVRTN	High Voltage Ground Return
Pin 17, 18	HVOUT	High Voltage Output
Pin 19, 20	+VIN	Positive Power Input
Pin 21, 22	PWRGND	Input Power Ground Return

Options

Append to Part #	Option Description	Not Compatible With
-V05	Enhanced Controls and Monitors, 0 to +5VDC	V10
-V10	Enhanced Controls and Monitors, 0 to +10VDC	V05
-H	Aluminum Heat Sink, 0.500in H	SS
-ST	Standoffs on Top of Cover, PCB Support	-
-SS	Threaded Studs for Mounting (#8-32x0.75)	H



V05 and V10 Options

Conditions		Value	Units
Output			
Current Scaling (I_{MON})	V05 Option, Buffered Signal	0 to +5 = 0 to 100% Rated Output	VDC
	V10 Option, Buffered Signal	0 to +10 = 0 to 100% Rated Output	
Voltage Scaling (V_{MON})	V05 Option, Buffered Signal	0 to +5 = 0 to 100% Rated Output	VDC
	V10 Option, Buffered Signal	0 to +10 = 0 to 100% Rated Output	
Programming & Controls			
Adjust Logic (V_{ADJ})	V05 Option	0 to +5 = 0 to 100% Rated Output	VDC
	V10 Option	0 to +10 = 0 to 100% Rated Output	
Reference Voltage (V_{REF})	Temperature +25°C, V05 Option	+5 ± 0.5%	VDC
	Temperature +25°C, V10 Option	+10 ± 0.5%	
Enable/Disable HV_{OUT}	-	Unconnected = Disabled; Ground to +0.5 = Disabled; +2.4 to 32 = Enabled	VDC
Mode Indicator	IMODE	Open Drain, Pulled Low When Active, 0 to 60V and 100mA Max	-
	VMODE	Open Drain, Pulled Low When Active, 0 to 60V and 100mA Max	

60W & 125W Models

Pin Assignments & Connections		
Pin 1, 8	PWRGND	Input Power Ground Return
Pin 2, 9	+VIN	Positive Power Input
Pin 3	IMON	Output Current Monitor
Pin 4	ENABLE	Enable/Disable
Pin 5	SIGGND	Signal Ground Return
Pin 6	VADJ	Voltage Adjust
Pin 7	VREF	Voltage Reference
Pin 10	N/C	N/C
Pin 11	IMODE	Current Mode Indicator
Pin 12	VMODE	Voltage Mode Indicator
Pin 13	IADJ	Current Adjust
Pin 14	VMON	Output Voltage Monitor
Pin 15, 16	HVRTN	High Voltage Ground Return
Pin 17, 18	HVOUT	High Voltage Output

250W Models

Pin Assignments & Connections		
Pin 1, 8	N/C	N/C
Pin 2, 9	N/C	N/C
Pin 3	IMON	Output Current Monitor
Pin 4	ENABLE	Enable/Disable
Pin 5	SIGGND	Signal Ground Return
Pin 6	VADJ	Voltage Adjust
Pin 7	VREF	Voltage Reference
Pin 10	N/C	N/C
Pin 11	IMODE	Current Mode Indicator
Pin 12	VMODE	Voltage Mode Indicator
Pin 13	IADJ	Current Adjust
Pin 14	VMON	Output Voltage Monitor
Pin 15, 16	HVRTN	High Voltage Ground Return
Pin 17, 18	HVOUT	High Voltage Output
Pin 19, 20	+VIN	Positive Power Input
Pin 21, 22	PWRGND	Input Power Ground Return

Certifications and Compliances

